

LAPORAN PUBLIKASI ILMIAH

CONDITION OF SEAGRASS BEDS ECOSYSTEM ON PONCAN GADANG ISLAND BASED ON MACROZOOBENTHOS DIVERSITY

Diajukan sebagai syarat untuk mendapatkan gelar kesarjanaan/Diploma*⁾ pada program studi
Pendidikan Biologi Fakultas keguruan dan Ilmu Pendidikan Universitas Labuhanbatu



ELPIYANI
1904100023

**PROGRAM STUDI PENDIDIKAN BIOLOGI
FAKULTAS KEGURUAN DAN ILMU PENDIDIKAN
UNIVERSITAS LABUHANBATU
RANTAU PRAPAT
2023**

LEMBAR PENGESAHAN PERSETUJUAN

JUDUL : Condition of Seagrass Beds Ecosystem on
Poncan Gadang Island Based on
Macrobenthos Diversity

NAMA JURNAL/PROSIDING/BUKU : Jurnal Penelitian Pendidikan IPA (JPPIPA)

VOLUME, NOMOR, TAHUN : 9, 3, 2023

HALAMAN : 1277-1282

TERINDEKS : Sinta 2

NAMA MAHASISWA : Elphyani

NPM : 1904100023

PRODI : Pendidikan Biologi

DOSEN PENDAMPING : Rusdi Machrizal, S.Pi., M.Si

DISETUJUI SEBAGAI PENGGANTI SKRIPSI (PILIHAN TUGAS AKHIR)

Pada tanggal : 22 Desember 2022

Disetujui Oleh :

Dosen Pembimbing



Rusdi Machrizal, S.Pi., M.Si

NIDN. 0127038602

Disahkan Oleh :

Kepala Program Studi Pendidikan Biologi



Risma Delima Harahap, S.Pd, M.Pd

NIDN. 0170108502

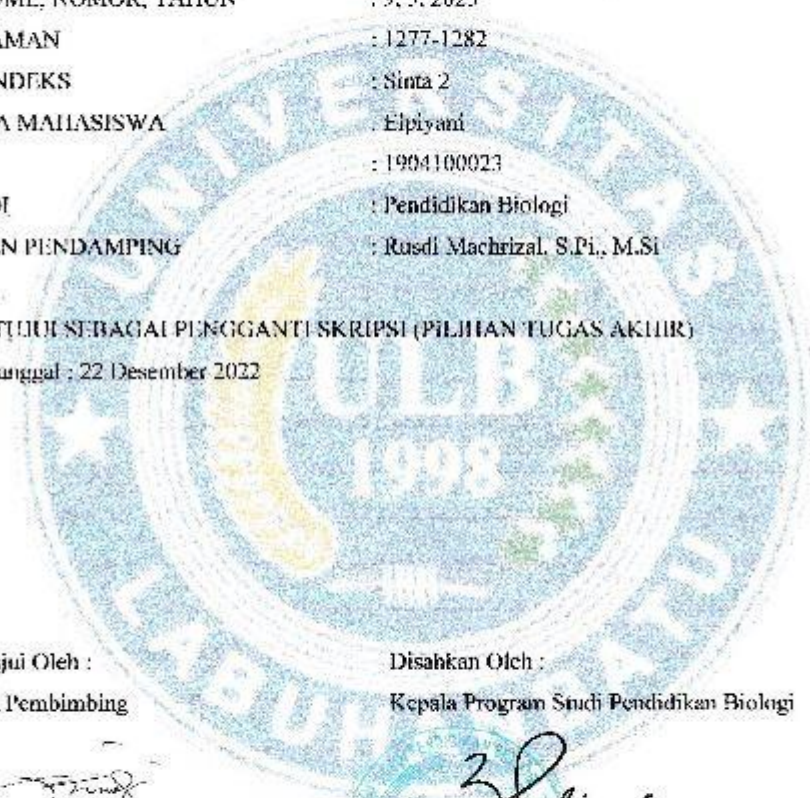

LEMBAR TINDAK LANJUT

Nama Mahasiswa : Elpiyani
NPM : 1904100023
Program Studi : Pendidikan Biologi
Judul Artikel : Condition of Seagrass Beds Ecosystem on Poncan Gadang
Island Based on Macrozoobenthos Diversity
Dipublikasikan Dijurnal : Jurnal Penelitian Pendidikan IPA (JPPIPA)
e_ISSN/p_ISSN : 2407-795X/2460-2582)
Volume, Nomor, Tahun : 9, 3, 2023
Terindeks Pada Sinta 2

BERDASARKAN KETERANGAN DAN DATA TERLAMPIR BAHWA KARYA ILMIAH (ARTIKEL) DENGAN JUDUL, CONDITION OF SEAGRASS BEDS ECOSYSTEM ON PONCAN GADANG ISLAND BASED ON MACROZOOBENTHOS DIVERSITY

DIPUTUSKAN :

1. MELAKSANAKAN UJIAN PENDAHULUAN KARYA ILMIAH

Disahkan pada tanggal: 31 Maret 2023
Kepala Program Studi Pendidikan Biologi

Disahkan Oleh :
Dekan Fakultas Keguruan dan Ilmu
Pendidikan

Risma Delima Harahap, S.Pd,M.Pd
NIDN. 0170114502

Dr. Sakinah Ubudiyah Siregar, M.Pd
NIDN. 0109048702

KATA PENGANTAR

Alhamdulillah Puji syukur penulis sampaikan kepada Allah SWT, yang telah memberikan banyak kesehatan dan kesempatan sehingga dapat menyelesaikan karya ilmiah yang menjadi salah satu syarat untuk mendapatkan gelar kesarjanaaan pada Program Studi Pendidikan Biologi Fakultas Keguruan dan Ilmu Pendidikan Universitas Labuhanbatu. Karya ilmiah yang berjudul " Condition of Seagrass Beds Ecosystem on Poncan Gadang Island Based on Macrozoobenthos Diversity " ini disusun dengan penuh usaha hingga terpublikasi pada Jurnal Penelitian Pendidikan IPA (JPPPIPA) Universitas Mataram yang terindeks SINTA 2. Penyusunan hingga terpublikasinya karya ilmiah ini kedalam Jurnal tidak terlepas atas bantuan dan dukungan banyak pihak. Ucapan terimakasih sebesar-besarnya penulis ucapkan kepada

1. Rektor Universitas Labuhanbatu Ade Parlaungan Nasution SE., M.Si, Ph.D
2. Dekan FKIP Dr. Sakinah Ubudiyah Siregar, S.Pd.I.,M.Pd
3. Kaprosdi Pendidikan Biologi Risma Delima Harahap S.Pd., M.Pd
4. Dosen Pembimbing Rusdi Machrizal, S.Pi., M.Si
5. Kepada Orangtua yang telah mendukung saya

Karya ilmiah yang terpublikasi ini tentunya masih memerlukan adanya masukan dan saran sehingga kedepan karya ilmiah ini dapat dijadikan rujukan pada karya-karya ilmiah yang akan datang

Rantauprapat, 07 Maret 2023



Elpiyani

JURNAL PENELITIAN PENDIDIKAN IPA

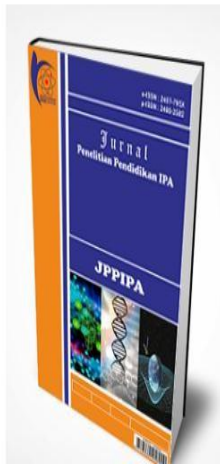

Jurnal Penelitian Pendidikan IPA (e_ISSN: 2407-795X, p_ISSN: 2460-2582) contains scientific articles form of research results that include science, technology, and teaching in the field of science. **Jurnal Penelitian Pendidikan IPA** is published monthly. Authors across the globe are welcome to submit their research papers in the prestigious journal fulfilling the requisite criterion.

Jurnal Penelitian Pendidikan IPA Collaborate with: **Perkumpulan Pendidik IPA Indonesia**.

Jurnal Penelitian Pendidikan IPA provides immediate **OPEN ACCESS** to its content on the principle that making research freely available to the public supports a greater global exchange of knowledge.



[EDITORIAL TEAM](#)

[REVIEWERS](#)

[FOCUS & SCOPE](#)

[PUBLICATION ETHICS](#)

[INDEXING AND ABSTRACTING](#)

[ARCHIVING INFORMATION](#)

[PUBLICATIONS FEES](#)

[SCOPUS CITATION ANALYSIS](#)

[DOWNLOAD FULL ISSUE](#)

Jurnal Penelitian Pendidikan IPA index by: [Crossref](#) | [Sinta DIKTI](#) | [Indonesian Public Index \(IPI\)](#) | [Google Scholar](#) | [Indonesian One Search](#) | [Bielefeld Academic Search Engine \(BASE\)](#) | [Index Copernicus International \(ICI\)](#) | [World of Journals](#) | [PKP Index](#) | [Academic Recource Index](#) | [Mendeley](#) | [Garuda Ristekdikti](#) | [More...](#)

Authors who publish with **Jurnal Penelitian Pendidikan IPA**, agree to the following terms:

1. Authors retain copyright and grant the journal right of first publication with the work simultaneously licensed under a Creative Commons Attribution 4.0 International License (CC-BY License). This license allows authors to use all articles, data sets, graphics, and appendices in data mining applications, search engines, websites, blogs, and other platforms by providing an appropriate reference. The journal allows the author(s) to hold the copyright without restrictions and will retain publishing rights without restrictions.
2. Authors are able to enter into separate, additional contractual arrangements for the non-exclusive distribution of the journal's published version of the work (e.g., post it to an institutional repository or publish it in a book), with an acknowledgment of its initial publication in Jurnal Penelitian Pendidikan IPA.
3. Authors are permitted and encouraged to post their work online (e.g., in institutional repositories or on their website) prior to and during the submission process, as it can lead to productive exchanges, as well as earlier and

JOURNAL TEMPLATE



NATIONALLY ACCREDITED



website) prior to and during the submission process, as it can lead to productive exchanges, as well as earlier and greater citation of published work (See The Effect of Open Access).

Publication Fee: 1.250.000 (IDR). [Read more about Publication Fees.](#)

ANNOUNCEMENTS

NEWS

📅 2022-10-10

Dear, Authors

Based on the decision of the editorial team and the decision of the **PUSAT NASIONAL ISSN INDONESIA (LIPI)**, the **Jurnal Penelitian Pendidikan IPA (JPPIPA)** will be published every month at least 60 articles published per edition. This decision will be enforced for Volume 8 Number 4 October 2022.

We have also prepared several articles for publication in volume 8 number 5 November 2022, and volume 8 number 6 December 2022.

Thank you

Best Regards

[READ MORE >](#)

KEYWORDS



JOURNAL STATCOUNTER



JOURNAL VISITORS



OFFICIAL WEBSITE OF JURNAL PASCASARJANA, UNIVERSITAS MATARAM

The Open Access Journals of Postgraduate University of Mataram provides quality journal publication services to documenting and preserving scientific article from the results of your research.

CONTACT US

📞 Phone. 081936732708
📠 Fax. 0370-7506625
✉ Mail. jurnalpasca@unram.ac.id
🌐 Web.
<https://www.jpjppipa.unram.ac.id>

OFFICIAL LINK

Institutional Website
Institutional Repository
Proceedings
Publications

SHARE & FOLLOW



HOME ARCHIVES Vol. 9 No. 3 (2023): March

Vol. 9 No. 3 (2023): March



Twenty Five Edition

Jurnal Penelitian Pendidikan IPA (JPPIPA) - Journal of Research in Science Education
(e-ISSN:2407-795X, p-ISSN:2460-2582).

PUBLISHED: Mar 31, 2023

ISSUE DOI: 10.29303/jppipa.v9i3

ARTICLES "REGULAR ISSUE"

Development of Interactive Electronic Module for Charged Reaction Rate Science Technology Engineering and Mathematics (STEM)

Riema Alfina Indriana, Anur Kemasulita

977-986

Increasing Students' Creativity and Learning Outcomes on Substance Pressure Materials with The Mind Mapping Learning Method

Nurulwati Nurulwati, Putriana Putriana, Nurhayati Nurhayati, Susanna Susanna, Mustar Mustar

987-992

[PDF](#) This article have been read 61 times, downloaded 54 times

Digital Literacy Ability of Students of Biology Education Study Program FSST Undikma

Herdyana Fitriani, Taufik Samsuri, M Zaihuudin

993-1000

[PDF](#) This article have been read 37 times, downloaded 40 times

Analysis of Scientific Literacy Ability Junior High School Students in Science Learning on Environmental Pollution

Inggird Ayu Amala, Sutarto Sutarto, Pramudya Dwi Anistya Putra, Indrawati Indrawati

1001-1005

[PDF](#) This article have been read 28 times, downloaded 36 times

A Musschenbroek Learning Media with Arduino Based with Relay and Max6675 Sensor to Increase HOTS and Creativity

Soka Hadladi, Adi Pramuda, Matsun Matsun

1006-1011

[PDF](#) This article have been read 24 times, downloaded 30 times

Impacts of Global Warming on Public Health in Natural Science: Elementary Student's HOTS and PEB in Environmental Education

Imi Zajuli Ichsan, Dwi Wahyuni, Anggit Merliana

1012-1017

Student Learning Resources on Learning Outcomes

Apit Fathurohman, Ahmad Fali Okillas, Leni Marina, Lintang Auliya Kurniati, Eri Susiloningsih, Azhar Azhar, Samsuryadi Samsuryadi

1018-1023

[PDF](#) This article have been read 38 times, downloaded 75 times

Need Analysis to Develop a Physics Module Integrated Natural Disaster and Mitigation

Nalia Fauza, Neni Hermita, Eri Afriyanti

1024-1029

[PDF](#) This article have been read 22 times, downloaded 34 times

How does PBL Brainwriting Method Supplemented with Concept Mapping Effective to Improve Critical Thinking and Problem-Solving Ability?

Rizki Khairani, Suyitno Aloysius

1030-1038

[PDF](#) This article have been read 25 times, downloaded 21 times

Analysis of Changes in Students' Scientific Literacy Ability After Attending Lectures Using the RADEC Model

Wati Sukmawati, Zulherman Zulherman

1039-1044

[PDF](#) This article have been read 20 times, downloaded 20 times

Potential Antimicrobial Ethyl Acetate Extracts of Ur Burst Shells Against S.aureus Bacteria From Diabetic Foot Wounds

Hardani Hardani, Dhika Juliana Sukmana, Bustanul Atfal, Ajeng Dian Perbiwi

1045-1049

[PDF](#) This article have been read 27 times, downloaded 28 times



- EDITORIAL TEAM
- REVIEWERS
- FOCUS & SCOPE
- PUBLICATION ETHICS
- INDEXING AND ABSTRACTING
- ARCHIVING INFORMATION
- PUBLICATIONS FEES
- SCOPUS CITATION ANALYSIS
- DOWNLOAD FULL ISSUE

JOURNAL TEMPLATE



NATIONALLY ACCREDITED



KEYWORDS



JOURNAL STATCOUNTER



JOURNAL VISITORS



- The Impact of Changes in the Learning System on Students' Learning Motivation**
 Muhammad Wahyu Rizki, Evendi Evendi, Muhammad Syukri, Saminan Saminan, Mursal Mursal 1059-1063
[PDF](#) This article have been read 26 times, downloaded 16 times
- Analysis of Problem Solving Skills of Class VII Students on Earthquake Material and Mitigation**
 Rosalia Tunika Grandis, Insih Wilujeng, Suyanta Suyanta 1064-1068
[PDF](#) This article have been read 17 times, downloaded 13 times
- Self Organized Learning Environments (SOLE) Model Based on Blended Learning for Independence and Students' Cognitive Learning Outcomes in Acid-Base Material**
 Ika Bujayaningih, Retno Allyatul Fikroh 1069-1075
[PDF](#) This article have been read 20 times, downloaded 14 times
- Sway-Based Interactive Chemistry Learning Media: Feasibility for Improving Students' Conceptual Understanding and Self-efficacy**
 Siti Nor Laili Hikmah, Parham Saadi, Anif Sholahuddin 1076-1084
[PDF](#) This article have been read 17 times, downloaded 18 times
- The Influence of Listening Team Learning (LTL) Model on Students' Learning Outcome in Science**
 Sudirman Sudirman 1085-1091
[PDF](#) This article have been read 35 times, downloaded 30 times

Learning Tools Quality of Problem-Based Learning Model in Contextual Teaching and Learning Approach on

- Condition of Seagrass Beds Ecosystem on Poncan Gadang Island Based on Macrozoobenthos Diversity**
 Elpiyani, Ruri Rimenta Ximenez Diaz, Nuratika Ranza, Diana Khairiyah Sirait, Rusdi Machrizal 1277-1282
[PDF](#) This article have been read 21 times, downloaded 22 times
- Conformity Level Analysis of Physics Daily Test Questions Based on Minimum Competency Assessment**
 Lutfiyah Khairi, Desnita 1283-1291
[PDF](#) This article have been read 16 times, downloaded 14 times
- Possible Usage of Various Microalgae Species from Rawa Besar Small Lake as Aquaculture Feedant**
 Fadhilurrahman Maulana, Nining Setawati Pribantini 1292-1296
[PDF](#) This article have been read 17 times, downloaded 13 times
- Secondary Science Teachers Perception on STEM Learning for Sustainable Development**
 Abdul Aziz Rahman, Ida Kanawati, Riandi, Sumar Hendayana 1297-1303
[PDF](#) This article have been read 68 times, downloaded 34 times

HOME ARCHIVES VOL. 9 NO. 3 (2023) MARCH Articles "Regular Issue"



Condition of Seagrass Beds Ecosystem on Poncan Gadang Island Based on Macrozoobenthos Diversity

Elpiyani, Ruri Rimenta Ximenez Diaz, Nuratika Ranza, Diana Khairiyah Sirait, Rusdi Machrizal

DOI: 10.29303/jppipa.v9i3.2320
 Published: 2023-03-31

PLUMX METRICS



Issue: Vol. 9 No. 3 (2023): March
 Keywords: Macrozoobenthos, Poncan Gadang Island, Seagrass ecosystem



- EDITORIAL TEAM
- REVIEWERS
- FOCUS & SCOPE
- PUBLICATION ETHICS
- INDEXING AND ABSTRACTING
- ARCHIVING INFORMATION
- PUBLICATIONS FEES
- SCOPUS CITATION ANALYSIS
- DOWNLOAD FULL ISSUE

JOURNAL TEMPLATE



ARTICLES "REGULAR ISSUE"

PDF

HOW TO CITE

Elpiyani, E., Diaz, R. R. X., Ranza, N., Sirait, D. K., & Machrizal, R. (2023). Condition of Seagrass Beds Ecosystem on Poncan Gadang Island Based on Macrozoobenthos Diversity. *Jurnal Apresiasi Pendidikan IPA*, 5(3), 1277-1282. <https://doi.org/10.25935/jppipa.v5i3.2320>

More Citation Formats

Facebook Twitter Email Print 0

DOWNLOADS

METRICS

PDF views 22

Abstract References License



NATIONALLY ACCREDITED



KEYWORDS



JOURNAL STATCOUNTER



ABSTRACT

The seagrass ecosystem of Poncan Gadang island is one of the ecosystems that often come under pressure due to ecotourism activities. Pressure on these ecosystems can have an impact on the diversity of the types of animals that live in them. This research is aimed at knowing the condition of seagrass ecosystems based on the diversity of macrozoobenthos that live in them. The observation point is divided into 5 stations. At each point, a square transect of 1x1 meters is made as many as 10 pieces. Collection of macrozoobenthos samples is carried out by the hand sorting method. The samples collected were then identified at the Ecology Laboratory of the Faculty of Teacher Training and Education, University of Labuhanbatu. Data analysis uses the Shannon Wiener Index (H'), Dominance Index (C) and Similarity Index (S) formulas. Data analysis was done by computer program Plymouth Routines In Multivariate Ecological Research (Primer) 7th version. The results showed that there were 30 species of macrozoobenthos living in the seagrass ecosystem of Poncan Gadang island, with a diversity index (H') of 3.031-3.191, a dominance index (C) of 0.0038 - 0.0053, then a similarity index (S) of 86.792 - 98.305%. This result indicates the condition of the seagrass beds ecosystem of Poncan Gadang Island is in good condition, with a moderate level of uniformity, low dominance and high similarity.



JOURNAL VISITORS



BUKTI PRINT OUT INDEKSING JURNAL

SINTA Author Subjects Affiliations Sources FAQ WCU Registration Login

Get More with SINTA Insight [Go to Insight](#)



JURNAL PENELITIAN PENDIDIKAN IPA (JPPIPA)
UNIVERSITAS MATARAM
P-ISSN : 24602582 < E-ISSN : 2407795X Subject Area : Science, Education, Agriculture, Engineering

1.60538
Impact Factor

3106
Google Citations

Sinta 2
Current Accreditation

[Google Scholar](#) [Garuda](#) [Website](#) [Editor URL](#)

History Accreditation

Year	Accreditation Status
2017	Accredited
2018	Accredited
2019	Accredited
2020	Accredited
2021	Accredited
2022	Accredited
2023	Accredited
2024	Accredited
2025	Accredited

Citation Per Year By Google Scholar

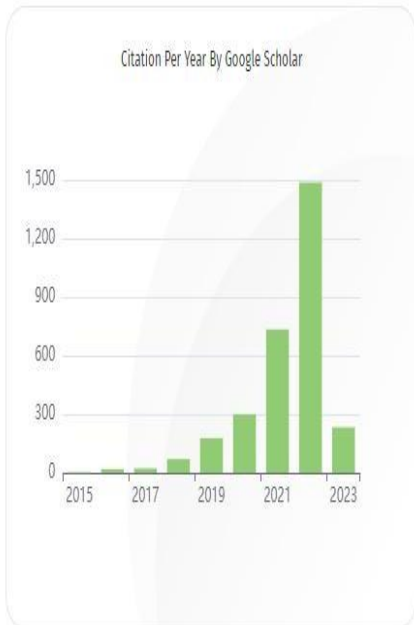

Year	Citation Count
2015	~10
2016	~20
2017	~30
2018	~50
2019	~100
2020	~200
2021	~700
2022	~1400
2023	~200

Journal By Google Scholar

	All	Since 2018
Citation	3106	3032
h-index	24	24

Condition of Seagrass Beds Ecosystem on Poncan Gadang Island Based on Macrozoobenthos Diversity

Elpiyani¹, Rury Rimenta Ximenez Diaz¹, Nuratika Ranza¹, Diana Khairiyah Sirait², Rusdi Machrizal^{1*}

¹, Biology education study program, University of Labuhanbatu, Rantauprapat, Indonesia.

², Mathematic education study program, University of Labuhanbatu, Rantauprapat, Indonesia.

Received: August 25, 2022

Revised: March 9, 2023

Accepted: March 25, 2023

Published: March 31, 2023

Corresponding Author:

Rusdi Machrizal

rusdimachrizal@gmail.com

DOI: [10.29303/jppipa.v9i3.2320](https://doi.org/10.29303/jppipa.v9i3.2320)

© 2023 The Authors. This open access article is distributed under a (CC-BY License



Abstract: The seagrass ecosystem of Poncan Gadang island is one of the ecosystems that often come under pressure due to ecotourism activities. Pressure on these ecosystems can have an impact on the diversity of the types of animals that live in them. This research is aimed at knowing the condition of seagrass ecosystems based on the diversity of macrozoobenthos that live in them. The observation point is divided into 5 stations. At each point, a square transect of 1x1 meters is made as many as 10 pieces. Collection of macrozoobenthos samples is carried out by the hand sorting method. The samples collected were then identified at the Ecology Laboratory of the Faculty of Teacher Training and Education, University of Labuhanbatu. Data analysis uses the Shannon Wiener index (H'), Dominance Index (C') and Similarity Index (IS) formulas. Data analysis was done by computer program Plymouth Routines In Multivariate Ecological Research (Primer) 7th version. The results showed that there were 30 species of macrozoobenthos living in the seagrass ecosystem of Poncan Gadang island, with a diversity index (H') of 3.031-3.191, a dominance index (C') of 0.0038 - 0.0053, then a similarity index (IS) of 86.792 - 98.305%. This result indicates the condition of the seagrass beds ecosystem of Poncan Gadang Island is in good condition, with a moderate level of uniformity, low dominance and high similarity.

Keywords: Macrozoobenthos; Poncan Gadang Island; Seagrass ecosystem

Introduction

Macrozoobentos are communities of organisms that live based on bottom or sediments in an aquatic habitat. They have a relatively fixed and very limited living habitat, therefore they are more susceptible to environmental disturbances such as changes in water quality and sediments, but are very well used as biological indicators determining conditions in the aquatic ecosystem (Bai'un et al., 2021; Saputri et al., 2021; Siahaan et al., 2021). Macrozoobenthos are a group of organisms that are often found alive associated with seagrass beds ecosystem (Machrizal et al., 2019).

Seagrass is one of the flowering plant communities that live in the intertidal zone (Machrizal et al., 2019; McKenzie et al., 2020; Thangaradjou & Bhatt, 2018). Seagrass is one of the communities in the coastal area that plays an important and effective role as one of the coastal protectors and land safety in coastal areas, so that seagrasses are also capable of stabilizes the substrate

(sediment), resists waves and absorbs contaminants (Sholihah et al., 2020). Seagrass beds are an environment that can providing life support for various types of marine organisms including macrozoobenthos. Seagrass beds are home to various types of fish and other biota for shelter, forage, lay eggs and raise cubs (Herawati et al., 2017).

Research on seagrass in Indonesia has been widely carried out by the researchers such as correlation of diversity macrozoobentos with seagrass density at Semawang Beach Sanur Bali (Sholihah et al., 2020), macrozoobentos community structure in ecosystems seagrass in Paciran, Lamongan Regency, East Java (Arfiati et al., 2019), density of macrozoobentos in vegetated areas (Seagrass) and un vegetated in Doreri Gulf Manokwari (Leatemia et al., 2017). Poncan Gadang Island is one of the one island located in the bay of Tapian Nauli, Madya Sibolga City. The island is become one of the tourist destinations for the community because it has a view beautiful underwater. Ecotourism

How to Cite:

Elpiyani, E., Diaz, R.R.X., Ranza, N., Sirait, D.K., & Machrizal, R. (2023). Condition of Seagrass Beds Ecosystem on Poncan Gadang Island Based on Macrozoobenthos Diversity. *Jurnal Penelitian Pendidikan IPA*, 9(3), 1277-1282. <https://doi.org/10.29303/jppipa.v9i3.2320>

activities in the waters of Poncan Gadang Island causing the surrounding ecosystem to gain pressure. Pressure against seagrass ecosystems that are constantly occurring are feared to cause the presence of macrozoobentos present in it becomes disturbed. Research this is intended to find out the condition of the seagrass ecosystem based on macrozoobenthos diversity on Poncan Gadang Island, so that it can utilized in the sustainable management of marine ecotourism.

Method

Time and Place

This research was carried out in 2021, sampling was carried out on Poncan Gadang Island. North Poncan Province Figure 1.

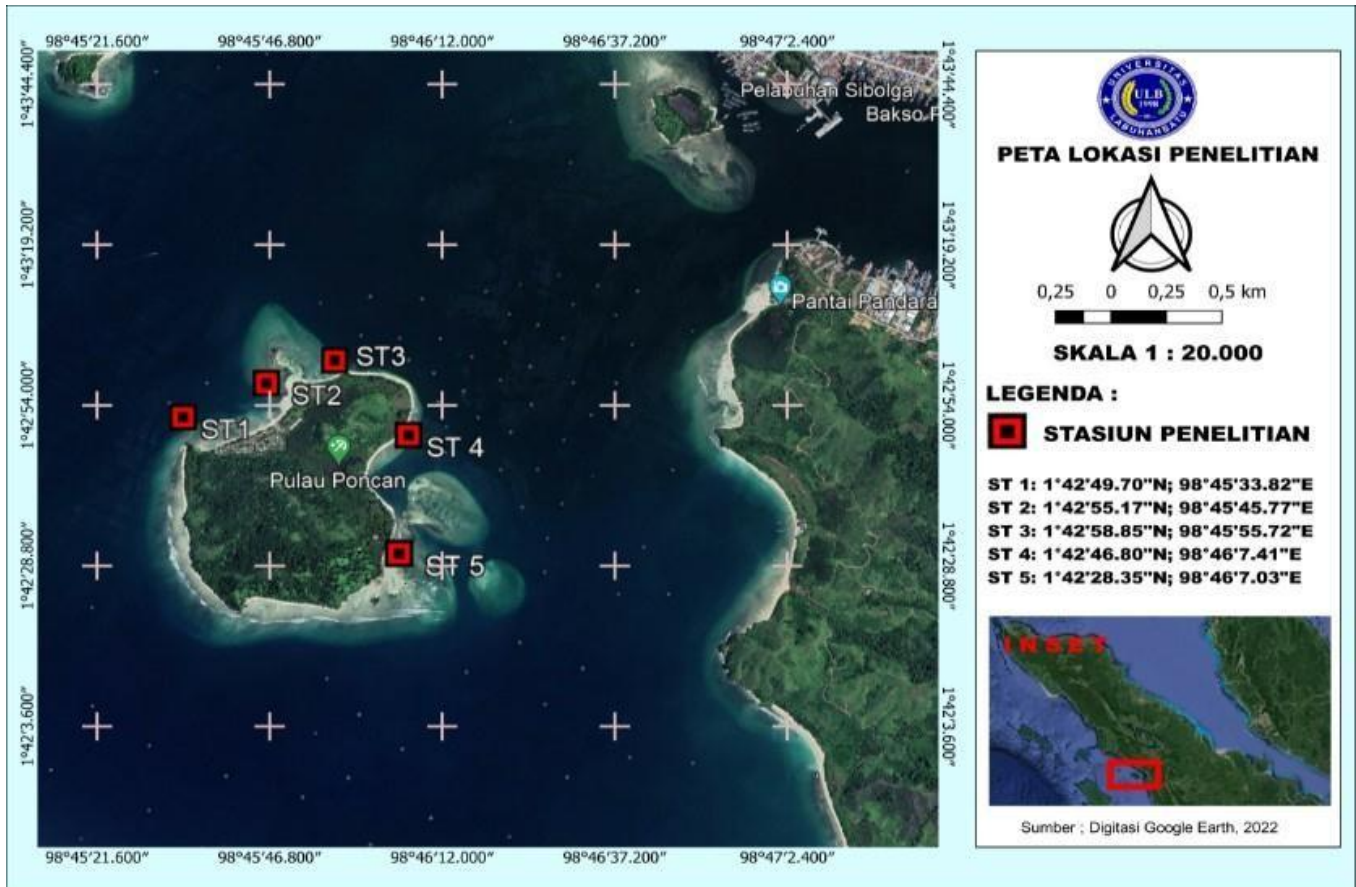

Figure 1. Research Location Map

Sampling Techniques

Sampling is carried out at low tide using the quadratic transect method. The transects used were 15 pieces per transect placement study site starting 10 meters from the shoreline to the sea, each transect was given a distance of 10 meters (Figure 2). Macrozoobenthos are taken using the Hand sorting technique. The samples obtained were collected and preserved with 70% alcohol to be identified in the integrated biological laboratory of Labuhanbatu University.

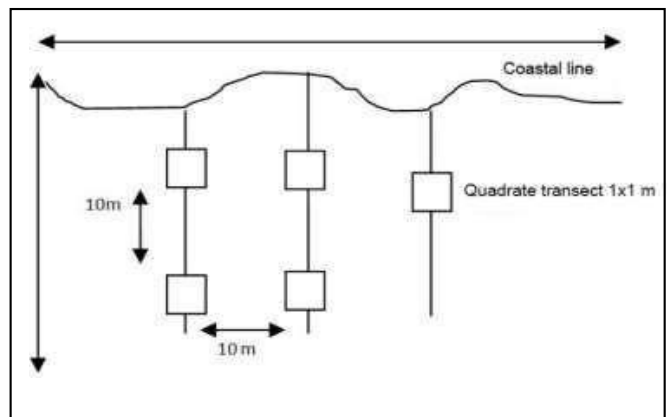

Figure 2. Illustration of transect laying (Sepriani et al., 2021)

Data Analysis

Diversity Index (H')

The diversity index (H') serves to describe the condition of population diversity mathematically in order to facilitate the process of analyzing the number of individuals of each type in a community. The calculation of the Diversity index (H') refers to the Shannon-Wiener equation (Krebs, 1989).

$$H' = - \sum_{i=1}^s (p_i \ln p_i) \tag{1}$$

Where:

H' = Shannon-Wiener diversity index

S = Number of species

Pi = Number of individuals of each type (i=1,2,3...)

With H' values :

0 < H' < 2,302 = low diversity

2,302 < H' < 6,907 = moderate diversity

H' > 6,907 = high diversity

Dominance Index (C)

The dominance index is used to obtain information about the species that dominate in a community. The formula is as follows (Odum, 1996) :

$$C = \frac{\sum_{i=1}^s n_i^2}{N^2} \tag{2}$$

information:

C = Index of dominance

Ni = Value of each species (number of i-th individuals)

N = the total value of the entire species (the total number of individuals that have been found)

The dominance index value ranges from 0–1. A C value close to 1 means that there is one species with high abundance at one location (there is only one species at one station). A value of C close to 0 indicates that no species with high abundance are found in a single location.

Similarity Index (IS) or Similarity Index

The similarity index is used to find similarities between species at each research station. The calculation uses the sorenson similarity formula (Barbour et al., 1998).

$$IS = \frac{2c}{a+b} \times 100\% \tag{3}$$

Where:

a = number of species at location a

b = number of species at location b

c = same number of species at locations a and b

with:

IS=75-100% : Very similar

IS=50-75% : Similar

IS=25-50% : Not similar

IS≤ 25% : Very unlikely

Data analysis in this study was carried out using the computer software Plymouth Routines software in Multivariate Research Version 7th. This software will also be used to create dendograms on the sorenson similarity index.

Result and Discussion

The results of the identification of samples collected from seagrass ecosystems in around poncan gadang island shows there are 30 species of macrozobentos the living ones are associated with seagrass ecosystems (Table 1). This result is not far away in contrast to those obtained (Machrizal et al., 2020) where there are 25 species macrozobenthos live associated in seagrass ecosystems on the beach of Natal, Sumatra North.

Table 1. The composition of macrozoobentos species in the seagrass ecosystem of poncan gadang island.

Species	ST 1	ST 2	ST3	ST 4	ST 5
<i>Littoria scabra</i>	+	+	+	+	+
<i>Cymatium Intermedium</i>	+	+	+	+	+
<i>Luria isabella</i>	+	+	+	+	+
<i>Terebridae</i>	+	+	+	+	+
<i>Pugettia gracilis</i>	+	+	+	+	+
<i>diodon holocanthus</i>	+	+	+	+	+
<i>Mauritia arabica</i>	+	+	+	+	+
<i>Asterias amurencis</i>	+	+	+	+	+
<i>Holothuria atra</i>	+	+	+	+	+
<i>Acrosterigma Cygnonim</i>	+	+	+	+	+
<i>Anadara trapezia</i>	+	+	+	+	+
<i>Sesarma sp</i>	+	+	+	+	+
<i>Actrina pectinata</i>	+	+	+	+	+
<i>Leganum Depressum</i>	+	+	-	+	+
<i>Anadara inaequevalvis</i>	+	+	+	+	+
<i>Perna viridis</i>	+	+	+	-	+
<i>Scylla oceanica</i>	+	-	+	-	+
<i>Dardanus calidus</i>	+	+	-	+	+
<i>Holothuria edulis</i>	+	+	+	+	+
<i>Ocypode kuhli</i>	+	+	+	+	+
<i>Holothuria scabra</i>	+	+	+	+	+
<i>Polinices lacteus</i>	+	+	+	+	+
<i>Atrina vexillum</i>	+	+	+	-	+
<i>Astraea caelata</i>	+	+	+	+	+
<i>Conus betulinus</i>	+	+	+	+	+
<i>Cryptochiton sp</i>	+	+	+	+	+
<i>Cypraea pyrum</i>	+	+	+	+	+
<i>Cypraea zonaria</i>	+	-	+	+	+
<i>Trochus niloticus</i>	+	+	-	+	+
<i>Faunus ater</i>	-	+	+	-	+

Note: (+) = Present; (-) = Absent

The results of the diversity index (H') analysis using shannonwiener's equation (table 2), show that the value of the diversity index macrozobentos on the island of poncan gadang are in the moderate category with H' value (3.031-3.191), this result is not much different from that obtained by (Herawati et al., 2017) in the waters of Natal Beach with an H' value (2.52-2.59), furthermore (Machrizal et al., 2020) get an H' value (2.89-2.98) in the ecosystem seagrass waters of Natal Beach. These results indicate that the condition macrozoobentos diversity on Poncan Gadang Island in the moderate category. Moderate diversity indicates that environmental conditions waters are quite supportive for macrozoobentos life and ecosystems seagrass in such locations has sufficient productivity, ecosystem conditions are sufficient balanced and moderate ecological pressure (Herawati et al., 2017; Machrizal et al., 2020; Siahaan et al., 2021; Wijana et al., 2019).

Table 2. Diversity Index (H') and Dominance (C') values

	Shannon Wiener Index (H')	Dominance Index(C')
Station 1	3.191	0.0053
Station 2	3.188	0.0047
Station 3	3.044	0.0049
Station 4	3.031	0.0049
Station 5	3.181	0.0038

The results of the analysis of the dominance index at the 5 research stations showed the value of close to 0, this indicates that on Poncan Gadang Island there is no one of the predominate types of macrozobentos (found in numbers a lot). A C value close to 1 means that there is one species with high abundance at one location (there is only one type at one station) (Azimah et al., 2021; Machrizal et al., 2020; Wahab et al., 2019). Value C close to 0 indicates that there are no species with high abundance that found in one location. The value of the acquired dominance index ranges from 0.0038 - 0.0053 and is classified as low. This result is not much different from that of the obtained (Herawati et al., 2017; Machrizal et al., 2020) where the index value dominance (C') in the seagrass ecosystem of Natal beach, North Sumatra is in range values from 0.002 to 0.009. This shows that the community is in a state of affairs stable, there has been no ecological pressure resulting in environmental changes. According to Machrizal et al., (2020) say that the presence of dominance indicates a place such have low kind of wealth with an uneven distribution, which says that within the observed community, there are species that dominate other species (Munandar et al., 2016). High and low diversity, and dominance at each observation station is due to temperature, salinity, pH, dissolved oxygen and behavior of an organism that is able to adjust itself to these environmental conditions (Alwi et al., 2020).

The value of the similarity index indicates the similarity of the types of macrobenthos fauna which composes a very high community (Taqwa et al., 2017) at a location that different. The similarity index at all research stations is within the range 86-98%. Station 1 with Station 5 has the most similarity index values high with a value of 98.305% while it is the lowest similarity index value found at station 3 with station 4 with a value of 86.792% (table 3).

Table 3. Similarity Index Value At the research site

IS	ST 1	ST 2	ST 3	ST 4	ST 5
Station 1					
Station 2	94.737				
Station 3	92.857	90.909			
Station 4	94.545	92.593	86.792		
Station 5	98.305	96.552	94.737	92.857	

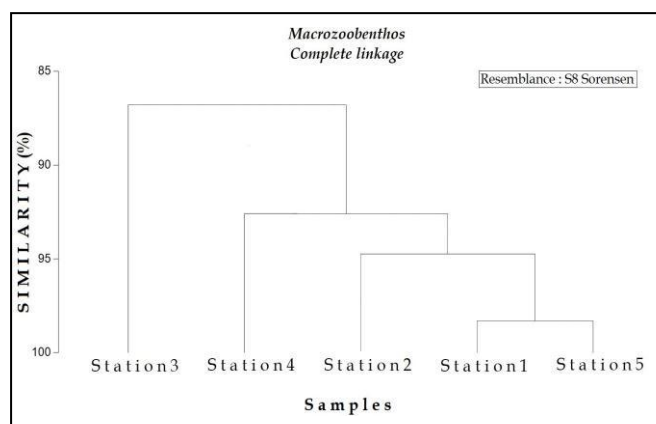

Figure 3. Dendrogram of Macrozoobenthos Similarity Index in Poncan Gadang Island Waters

Poncan Gadang Based on data analysis, we can see that the degree of similarity between species from 5 stations are very high because the index shows IS=75-100%. The results of this study are not much different from those obtained (Machrizal et al., 2020) above 90%. This high degree of similarity is due to the whole the research station has almost the same characteristics. Same thing expressed by (Ningrum & Kuntjoro, 2022; Ningsih et al., 2020; Sepriani et al., 2021) the value of the similarity index can be influenced by ecological factors and chemical physical factors at the research site. Almost the same ecological characteristics cause the similarity of species values in a region is very similar.

Conclusion

Judging from the level of macrozoobenthos diversity which is in the moderate category at the five observation points on poncan gadang island, this indicates that the condition of the seagrass ecosystem of Poncan Gadang Island is in good condition.

Acknowledgements

Thank you we convey to the Directorate General of Higher Education, Research, and Technology (Ditjen Diktiristek) through the Directorate of Learning and Student Affairs (Belmawa) which has financed this publication through the PKM AI scheme in 2022.

References

- Alwi, D., Muhammad, S. Hi., & Herat, H. (2020). Keanekaragaman Dan Kelimpahan Makrozoobentos Pada Ekosistem Mangrove Desa Daruba Pantai Kabupaten Pulau Morotai. *Jurnal Enggano*, 5(1), 64–77. <https://doi.org/10.31186/jenggano.5.1.64-77>
- Arfiati, D., Herawati, E. Y., Buwono, N. R., Firdaus, A., Winarno, M. S., & Puspitasari, A. W. (2019). Struktur Komunitas Makrozoobentos Pada Ekosistem Lamun di Paciran, Kabupaten Lamongan, Jawa timur. *Journal of Fisheries and Marine RESEARCH*, 3(1), 1–7. <https://doi.org/10.21776/ub.jfmr.2019.003.01.1>
- Azimah, N., Nurdin, M., & Zainal, S. (2021). Keanekaragaman Makrozoobentos Di Perairan Pusat Laut Kecamatan Banawa Kabupaten Donggala Serta Pemanfaatannya Sebagai Media Pembelajaran. <https://doi.org/10.22487/jbse.v9i2.1735>
- Bai'un, N. H., Riyantini, I., Mulyani, Y., & Zallesa, S. (2021). Keanekaragaman Makrozoobentos Sebagai Indikator Kondisi Perairan Di Ekosistem Mangrove Pulau Pari, Kepulauan Seribu. *Journal of Fisheries and Marine Research*, 5(2), 227–238. <https://doi.org/10.21776/ub.jfmr.2021.005.02.7>
- Barbour, M. G., Burk, J. H., & Pitts, W. D. (1998). *Terrestrial Plant Ecology* (3rd ed.). An Imprint of Addison Wesley Longman.
- Herawati, P., Barus, T. A., & Wahyuningsih, H. (2017). Keanekaragaman Makrozoobentos Dan Hubungannya Dengan Penutupan Padang Lamun (Seagrass) Di Perairan Mandailing Natal Sumatera Utara. *Jurnal Biosains*, 3(2). <https://doi.org/10.24114/jbio.v3i2.7434>
- Krebs, C. J. (1989). *Ecological Methodology*. Harper Collins Publisher.
- Leatemia, S. P. O., Pakilaran, E. L., & Kopalit, H. (2017). Macrozoobentos Abundance in the Vegetated (Seagrass) and Un-vegetated Areas of Doreri Bay-Manokwari. *Jurnal Sumberdaya Akuatik Indopasifik*, 1(1), 15–26. <https://doi.org/10.30862/jsai-fpik-unipa.2017.Vol.1.No.1.13>
- Machrizal, R., Khairul, K., Chastanti, I., Sari, N. F., Ritonga, N., & Sepriani, Y. (2019). A study on the density and the cover of seagrass species along the West Coast of Natal. *IOP Conference Series: Earth and Environmental Science*, 348(1). <https://doi.org/10.1088/1755-1315/348/1/012004>
- Machrizal, R., Khairul, K., & Dimenta, R. H. (2020). Diversity of Macrozoobentos on Seagrass Beds Ecosystem in Natal Waters North Sumatera. *Gorontalo Fisheries Journal*, 3(1), 56–67. <https://doi.org/10.32662/gfj.v3i1.998>
- McKenzie, L. J., Nordlund, L. M., Jones, B. L., Cullen-Unsworth, L. C., Roelfsema, C., & Unsworth, R. K. F. (2020). The global distribution of seagrass meadows. *Environmental Research Letters*, 15(7). <https://doi.org/10.1088/1748-9326/ab7d06>
- Munandar, A., Ali, Ms., Karina, S., (2016). Community Structure Macrozoobentos Estuari Kuala Rigaih District Of Setia Bakti Aceh Jaya. *Jurnal Ilmiah Mahasiswa Kelautan Dan Perikanan Unsyiah*, 1, 331–336. <https://jim.usk.ac.id/fkp/article/view/1605/pdf>
- Ningrum, N. C., & Kuntjoro, S. (2022). Kualitas Perairan Sungai Brangkal Mojokerto Berdasarkan Indeks Keanekaragaman Makrozoobentos. *LenteraBio*, 11(1), 71–79. <https://doi.org/https://doi.org/10.26740/lentera.bio.v11n1.p71-79>
- Ningsih, S. W., Setyati, W. A., & Taufiq-Spj, N. (2020). Tingkat Kelimpahan Makrozoobentos di Padang Lamun Perairan Telaga dan Pulau Bengkoang, Karimunjawa. *Journal of Marine Research*, 9(3), 223–229. <https://doi.org/10.14710/jmr.v9i3.27418>
- Odum E P. (1996). *Dasar-dasar ekologi* (3rd ed.). Gadjah Mada University Press.
- Saputri, A. E., Amin, B., & Yoswaty, D. (2021). Structure of The Macrozoobentos Community in The north coastal waters of Bengkalis Island, Riau Province. In *Asian Journal of Aquatic Sciences* (Vol. 4, Issue 3). <https://doi.org/10.31258/ajoa.4.3.225-235>
- Sepriani, Y., Simamora, S. S., Safitri, R., Machrizal, R., Dimenta, R. H., & Khairul, K. (2021). Seagrass diversity in Poncan Gadang Island, Sibolga, Indonesia (Vol. 14, Issue 1). <http://www.bioflux.com.ro/docs/2021.561-569.pdf>
- Sholihah, H., Arthana, I. W., & Ekawaty, R. (2020). Hubungan Keanekaragaman Makrozoobentos dengan Kerapatan Lamun di Pantai Semawang Sanur Bali. *Current Trends in Aquatic Science*, 3(1), 1–7. <https://ojs.unud.ac.id/index.php/CTAS/article/download/51245/36014>
- Siahaan, J. W., Warsidah, & Nurdiansyah, S. I. (2021). Structure of the Macrozoobentos Community at Gosong Beach, Sungai Raya Kepulauan District Bengkayang Rengency West Kalimantan. *Jurnal Laut Khatulistiwa*, 4(3), 130–138. <http://dx.doi.org/10.26418/lkuntan.v4i3.48095>

- Taqwa, A., Supriharyono, S., & Ruswahyuni, R. (2017). Primary productivity analysis of phytoplankton and community structure of macrobenthos based on mangrove density in conservation area of Tarakan City, East Kalimantan. *Bonorowo Wetlands*, 3(1), 30-40. <https://doi.org/10.13057/bonorowo/w030103>
- Thangaradjou, T., & Bhatt, J. R. (2018). Status of seagrass ecosystems in India. In *Ocean and Coastal Management* (Vol. 159, pp. 7-15). Elsevier Ltd. <https://doi.org/10.1016/j.ocecoaman.2017.11.025>
- Wahab, I., Madduppa, H., Kawaroe, M., & Nurafni. (2019). Analysis of Macrozoobenthic Density at Different Moon Phases in seagrass, Panggang, Seribu Islands Jakarta. *Jurnal Teknologi Perikanan Dan Kelautan*, 10(1), 93-107. <https://doi.org/10.24319/jtpk.10.93-107>
- Wijana, I. M. S., Ernawati, N. M., & Pratiwi, M. A. (2019). Keanekaragaman Lamun dan Makrozoobentos sebagai indikator kondisi Perairan Pantai sindhu, sanur, bali. *Ecotrophic*, 13(2), 238-247. <https://doi.org/10.24843/EJES.2019.v13.i02.p11>

SURAT PERMOHONAN

Kepada Yth:

Bapak/Ibu Kaprodi Risma Delima Harahap S.Pd., M.Pd

Di Tempat.

Saya yang bertanda tangan dibawah ini:

Nama : Elpiyani
NPM : 1904100023
Semester : VII(8)
Prodi : Pendidikan Biologi
Konsentrasi : Umum

Dengan ini memohon kiranya Bapak/Ibu Kaprodi Risma Delima Harahap S.Pd., M.Pd bersedia memberikan Persetujuan pada saya untuk mengajukan pengganti tugas akhir yaitu: Artikel Ilmiah. Adapun syarat-syarat yang telah ditetapkan oleh Universitas Labuhanbau telah saya penuhi. Sebagai bukti bagi bapak/ibu disini saya lampirkan:

1. Transkrip nilai sementara yang sudah disetujui oleh BAAK Fakultas
2. Draft Artikel
3. Lembar Pengesahan Keuangan dari Ka. Bidang Keuangan Universitas

Demikian saya sampaikan. Atas perhatian yang Bapak/Ibu berikan, saya ucapkan terimakasih.

Rantauprapat, 10 Desember 2022

Hormat Saya,

Elpiyani
1904100023



FAKULTAS KEGURUAN DAN ILMU PENDIDIKAN (FKIP) UNIVERSITAS LABUHANBATU

Program Studi :
PEND.BIOLOGI : Terakreditasi BAN-PT No. 547/SK/BAN-PT/Ak-PPJS/II/2022
PEND.PKN : Terakreditasi BAN-PT No. 4813/SK/BAN-PT/Ak-PNB/S/XII/2019
PEND.MATEMATIKA : Terakreditasi BAN-PT No. 4812/SK/BAN-PT/Ak-PNB/S/XII/2019
Kampus : Jl.SM. Raja No. 126-A KM.3,5 Aek Tapa - Rantauprapat - Sumatera Utara
Telepon / Fax (0624) 21901 - Website : fkip.ulb.ac.id

LEMBAR PENGESAHAN/PERSETUJUAN

Nama : Elpiyani
NPM : 1904100023
Semester : VIII (8)
Prodi : Pendidikan Biologi
Fakultas : Keguruan dan Ilmu Pendidikan
Total SKS yang Lulus : 148
Judul : Condition of Seagrass Beds Ecosystem on Poncan Gadang
Island Based on Macrozoobenthos Diversity
Pilihan Karya Ilmiah* : Artikel Nasional Terakreditasi
Terindeks* : Sinta 2
Status Karya Ilmiah* : Terbit
Dosen** : Rusli Machrizal, S.Pi., M.Si

DISETUJUI SEBAGAI PENGGANTI SKRIPSI (PILIHAN KARYA ILMIAH) Pada
Tanggal 22 Desember 2022

Disetujui Oleh :
Kepala Program Studi Pendidikan Biologi

Disahkan Oleh :
Dekan Fakultas Keguruan dan Ilmu
Pendidikan

Risma Delima Harahap, S.Pd,M.Pd
NIDN. 0130118502

Dr. Sakinah Ubudiyati Siregar, M.Pd
NIDN. 0109048702



FAKULTAS KEGURUAN DAN ILMU PENDIDIKAN (FKIP) UNIVERSITAS LABUHANBATU

Program Studi :
PEND.BIOLOGI : Terakreditasi BAN-PT No. 547/SK/BAN-PT/Ak-PPJ/S/2022
PEND.PKN : Terakreditasi BAN-PT No. 4813/SK/BAN-PT/Ak-PNB/S/XII/2019
PEND.MATEMATIKA : Terakreditasi BAN-PT No. 4812/SK/BAN-PT/Ak-PNB/S/XII/2019
Kampus : Jl. SM. Raja No. 126-A KM.3,5 Aek Tapa - Rantauprapat - Sumatera Utara
Telepon / Fax (0624) 21901 - Website : fkip.ulb.ac.id

LEMBAR PENUNJUKAN DOSEN PENDAMPING

Nama : Elpiyani
NPM : 19041100123
Semester : VIII (8)
Prodi : Pendidikan Biologi
Konsentrasi : Umum
Fakultas : Keguruan dan Ilmu Pendidikan
Total SKS yang Lulus : 151
Judul : Condition of Seagrass Beds Ecosystem on Poncan Ciadang
Island Based on Macrozoobenthos Diversity
Status Karya Ilmiah* : Terbit

Dengan ini menunjuk dan menetapkan dosen pendamping sebagai berikut :

Dosen** : Rusdi Machrizal, S.Pi., M.Si

Disahkan Oleh :

Dean Fakultas Keguruan dan Ilmu
Pendidikan



Dr. Sakinah Ubudiyah Siregar, M.Pd
NIDN. 0109048702